

syncro[®]

Opening a new chapter in
PVC-U patio doors



Made & recycled
in the UK



eurocell[®]

All together better

INTRODUCING NEW SYNCRO SLIDING PATIO DOORS



syncro[®]

NEW SLIDING PATIO DOORS

Introducing a new in-line system with even more benefits built in

We're always looking to improve our products, though. So to keep in pace with customer demand, while staying in step with building regulations, the brand new Syncro system is here. Building on our unrivalled experience, Syncro isn't just our strongest and most secure patio door yet. It also offers better sustainability, design and performance – for you and your customers.

A GREY REVOLUTION

The outstanding feature that makes Syncro so special, though, is its grey substrate option.

With a through-colour grey frame instead of just a surface foil, there's no sign of a white PVC-U core, even when you open the door.

It may seem like a small detail, but the all-grey look is a big thing with homeowners right now and many people are more than ready to pay a premium for it in PVC-U rather than choose the much more expensive aluminium option.

So make sure you're ready to supply everything they're looking for with the new Syncro sliding patio doors.

NEW



Syncro in Anthracite Grey

NEW

**GREY SUBSTRATE OPTION
FOR THE CONSISTENT LOOK**





syncro®

THE ALL NEW PATIO DOOR SYSTEM FROM EUROCELL

Eurocell leads the way in patio doors. In fact, we've long been the customer's choice when it comes to security, strength and performance with style.

Close to perfection in the patio door market

Syncro is available to PAS24 standards, which means you can meet Document Q - the newest security regulations for patio doors. Plus, its improved strength, security and weather performance mean it also satisfies BS6375 as standard.

But that's just for starters. What makes Syncro really stand out are these brand new features that help it make a really impressive entrance on the marketplace:

- More sustainable with frame composition made up of at least 40% PCW (post-consumer waste).
- Better thermal efficiency with U-values as low as 1.3 for double glazed units and 1.0 for triple glazed.
- Maximum width of 3.5m (2 pane)
- Triple as well as double glazing compatible for even better insulation.
- Grey substrate for total coordination with modern designs
- Soft close option

WHY CHOOSE SYNCRO?



**Width of up to
3.5m available**



**Fast, accurate
fabrication and
installation**



**U-values
as low as 1.0**



**Soft-close
option**



**A choice of frame
colours including
grey substrate option**



**Triple glazing
compatible**



**Delivery from
6 working days**



**10-year
guarantee for
peace of mind**



A WIDE SPECTRUM OF COLOURS

COLOURS THAT MATCH YOUR PLANS

Colours that match your plans

Like all Eurocell PVC-U products, the new Syncro system comes with an exact colour-match guarantee. That means the colour is precisely matched to all Eurocell window, door and conservatory roof products, creating a coordinated, consistent look across any property.

Syncro is normally manufactured with a white internal finish to maintain a bright, fresh interior, but some colours are available on both sides from stock.

Plus, Syncro doors are also available with a grey substrate for the look that's so much in demand at the moment.

Up to 10-year guarantee

Syncro patio door profiles are guaranteed for ten years. Which means you and your customers enjoy all the reassurance of a robust, well-designed, precision-made product that's built to last.

FRAME COLOURS FROM STOCK



WHITE
White interior

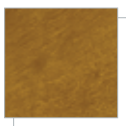

GOLDEN OAK
White interior

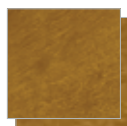

GOLDEN OAK
Both sides



ROSEWOOD
White interior



ROSEWOOD
Both sides



ANTHRACITE GREY
White interior

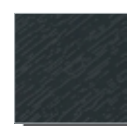

ANTHRACITE GREY
Grey base

FRAME COLOURS MADE TO ORDER

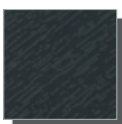

ANTHRACITE GREY SMOOTH
Grey base



ANTHRACITE GREY MATT
Grey base

32 ADDITIONAL COLOURS AND SPECIFICATIONS ARE MADE TO ORDER ON EXTENDED LEAD TIMES

Note: Grey base product features cool colours foil

HANDLE COLOURS



WHITE
White interior



HARDEX CHROME



HARDEX GRAPHITE



FEATURES & BENEFITS

MARKET-LEADING PATIO DOOR

MADE FROM 40%
**POST-CONSUMER
WASTE**

U-VALUE
AS LOW AS 1.0

PAS24 OPTIONS FOR.....
ULTIMATE SECURITY

DOUBLE OR TRIPLE
**GLAZING
OPTIONS**

SOFT CLOSE
OPTION

WIDTHS OF UP TO
3.5 METRES
(2 PANE)



Soft close eases door on closure to locking position

TECHNICAL INFORMATION

MINIMUM & MAXIMUM SIZES

PATIO DOORS



Sizes shown **do not** include cill.

For sizes outside min/max dimensions please contact Eurocell Technical department. Ensure suitable hardware is used that is capable of withstanding the sash weight.

All Sizes shown: MINIMUM - **MAXIMUM** in mm

syncro[®]
Sliding Patio Doors



- * Low threshold = 2400mm max height
- ** For 3201 - 3500mm door widths max door height = 2100mm
- *** For 4700 - 5000mm door widths max door height = 2100mm

TECHNICAL INFORMATION

SLIDING PATIO DOORS

STANDARD THRESHOLD

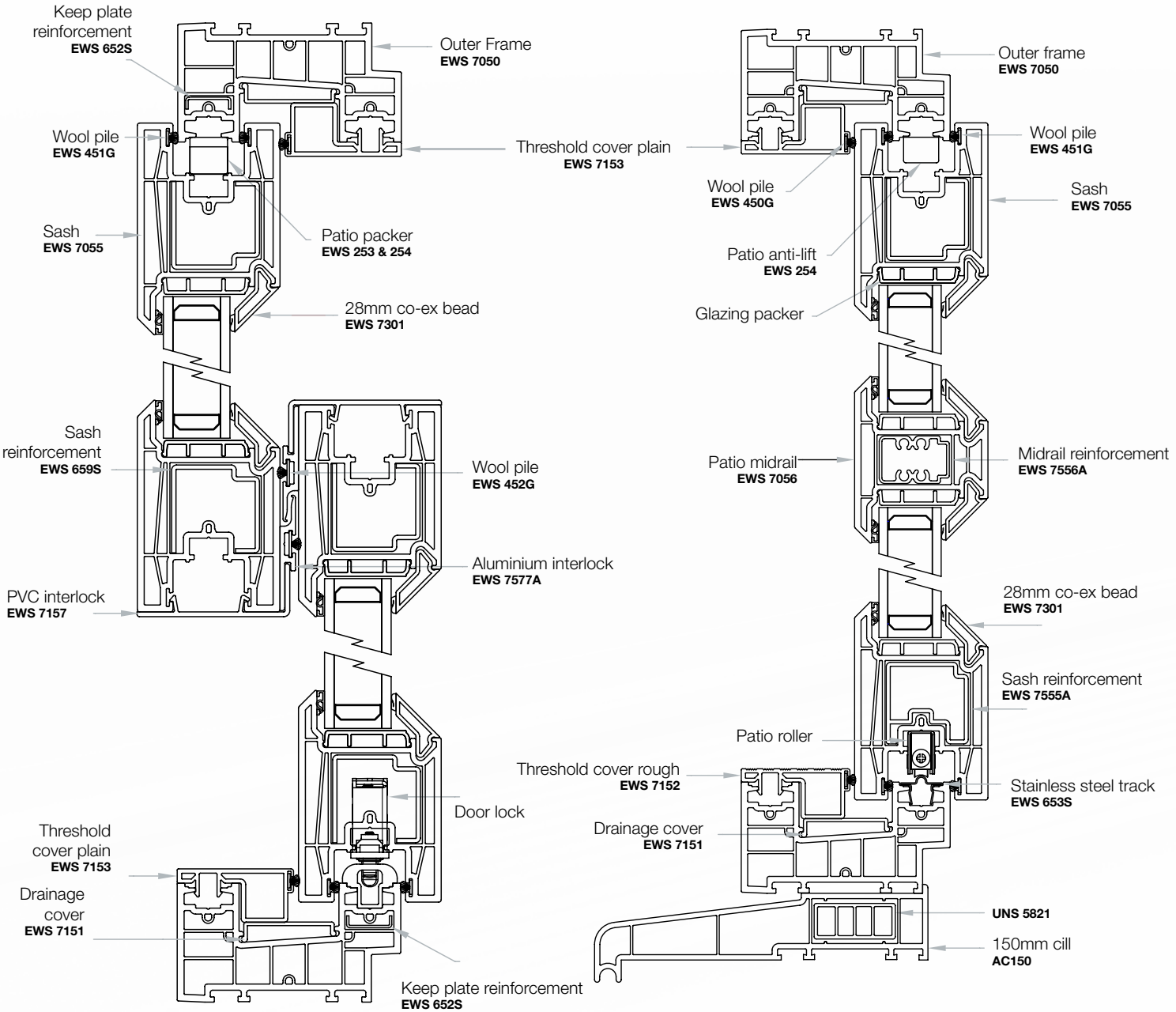

HORIZONTAL CROSS SECTION FOR 2 PANE STYLE

VERTICAL CROSS SECTION THROUGH SLIDING SASH

syncro®
Sliding Patio Doors

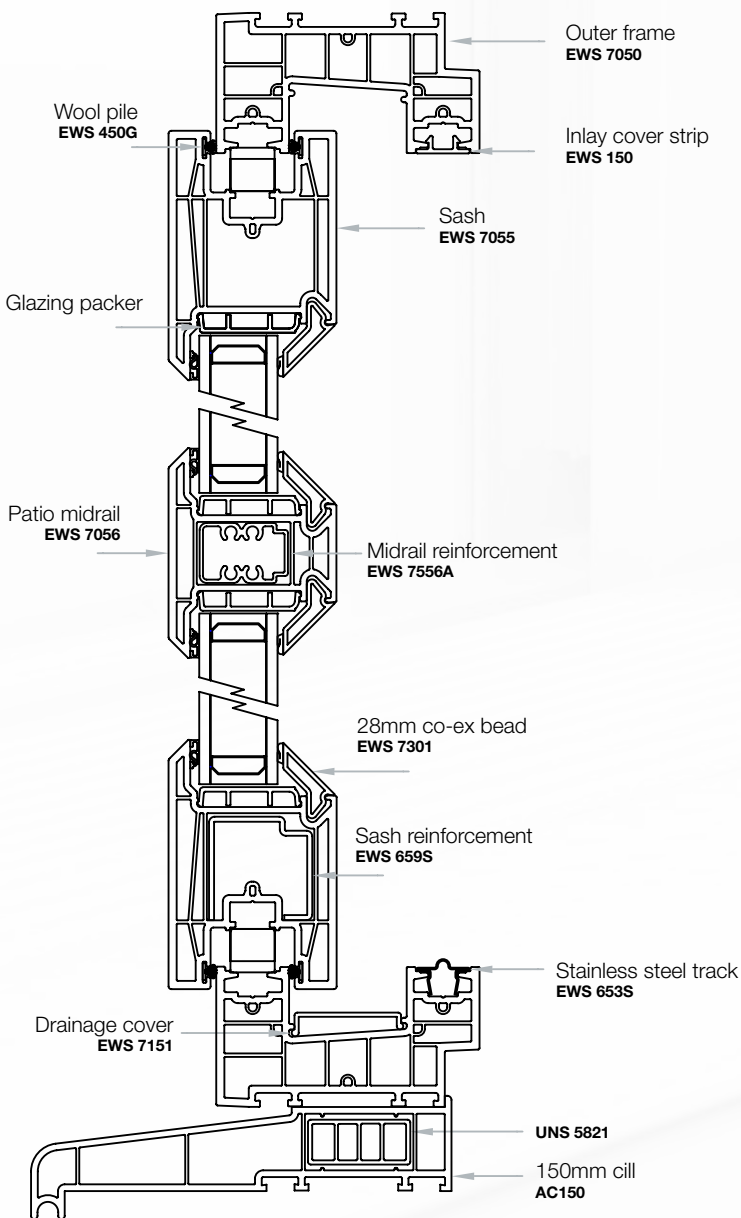

SLIDING SASH



FIXED SASH

VERTICAL CROSS SECTION THROUGH FIXED SASH

TECHNICAL INFORMATION

SLIDING PATIO DOORS

LOW THRESHOLD

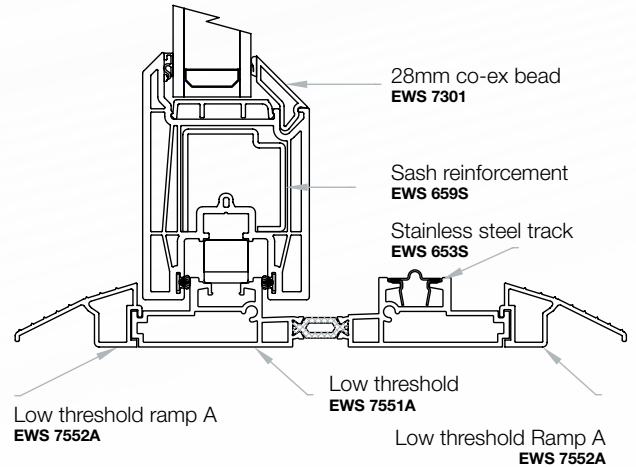
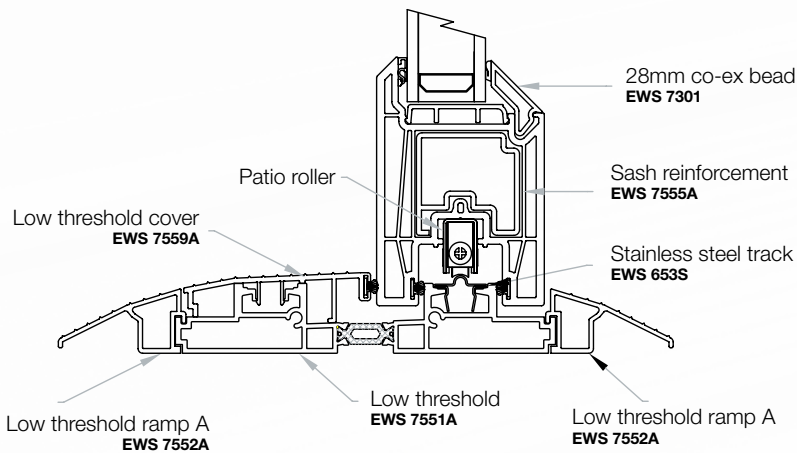
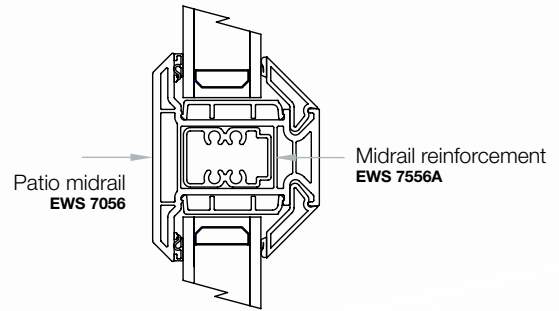
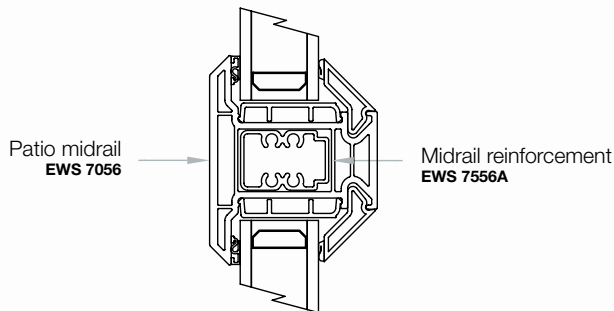
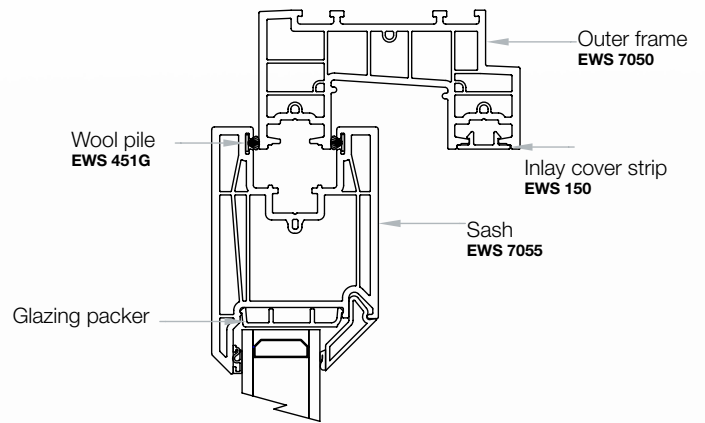
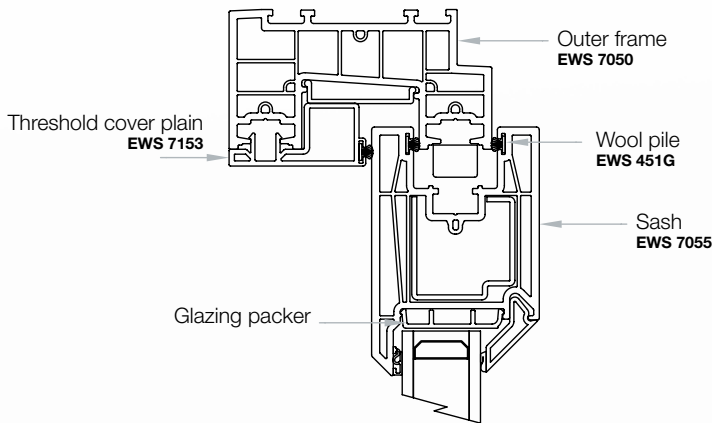

VERTICAL CROSS SECTION THROUGH SLIDING SASH WITH LOW THRESHOLD

VERTICAL CROSS SECTION THROUGH FIXED SASH WITH LOW THRESHOLD



Aluminium interlock



Soft close



Four independent moving rollers



Low threshold

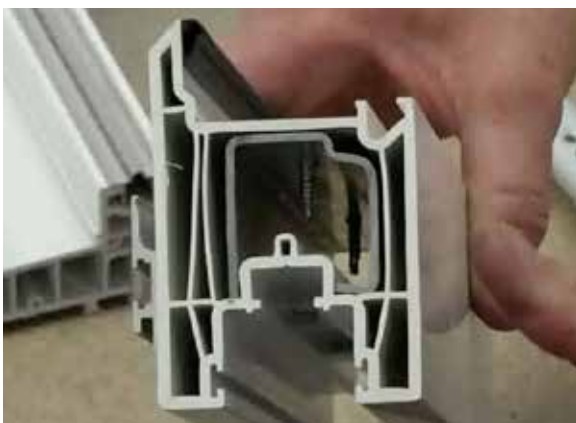

Thicker steel with full reinforcement



New hardware – flush option available

TECHNICAL INFORMATION

SYSTEM COMPONENTS

PVC-U COMPONENTS

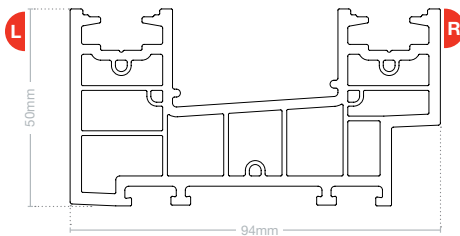

Outer frame
EWS 7050

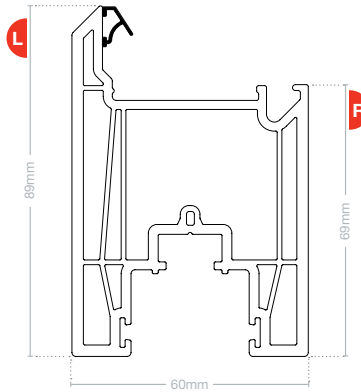

Sash
EWS 7055

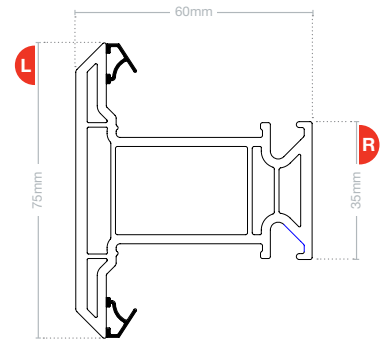

Midrail
EWS 7056

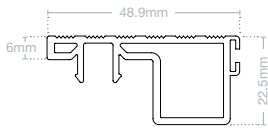

Threshold cover (rough)
EWS 7152

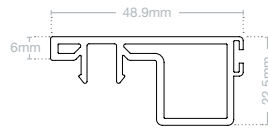

Threshold cover (plain)
EWS 7153

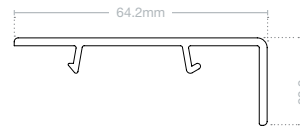

PVC Interlock
EWS 7157

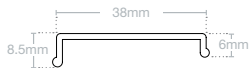

Drainage cover
EWS 7151



Glazing packer
EWS 7255



Inlay cover strip
EWS 150

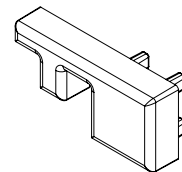

Crash stop
EWS 7453

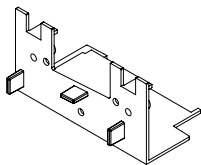

Frame mechanical joint moulding
EWS 7254

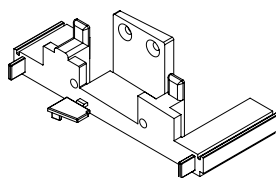

Low threshold moulding
EWS 7252

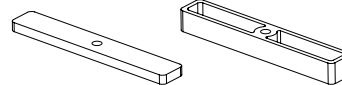

Fixed pane packer
EWS 253

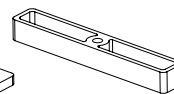

Anti-lift packer
EWS 254

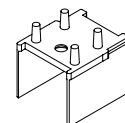

Meeting style end cap
EWS 7253



36mm Bead
EWS 7303



36mm Ovolo bead
EWS 7313

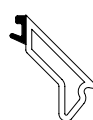

28mm Bead
EWS 7301

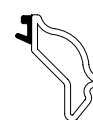

28mm Ovolo bead
EWS 7312

KEY Left face **L** Right face **R**

ALUMINIUM COMPONENTS

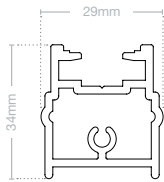

Meeting style
EWS 7533A

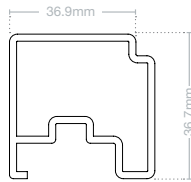

Sash reinforcing
EWS 7555A

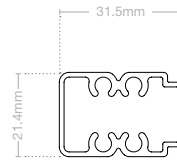

Midrail reinforcing
EWS 7556A



Interlock
EWS 7557A

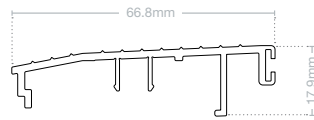

Threshold cover
EWS 7559A

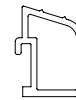

Low threshold ramp B
EWS 7558A

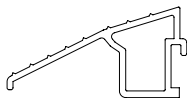

Low threshold Ramp A
EWS 7552A

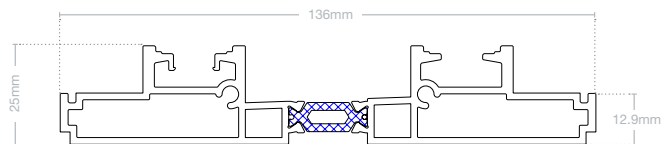

Low threshold
EWS 7551A

STEEL COMPONENTS

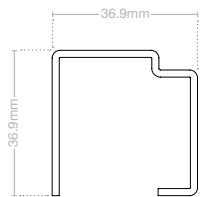

Heavy duty sash reinforcement
EWS 659S
EWS 660S (Punched)

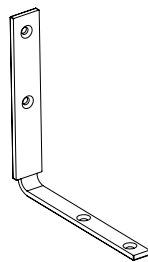

Fixed pane retention cleat
EWS 656S

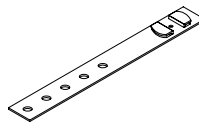

Fixing cleat
EWS 612S

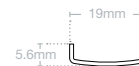

Keep plate reinforcement
EWS 652S

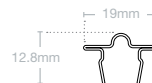

Stainless steel track
EWS 653S

GASKETS/SEALS



Grey wool pile gasket
(For use in threshold & interlock)
EWS 450G



Black wool pile gasket
(For use in sash only)
EWS 451G



Wool pile gasket
(For use in interlock only)
EWS 452G

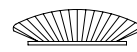

Mainframe drainage dam
(For internal sliding patios only)
EWS 453G



All together better

For more information about **syncro** sliding patio door system from Eurocell, call our customer services team on **0800 988 3047**, or visit **eurocell.co.uk/syncro**

Eurocell plc, Fairbrook House, Clover Nook Road, Alfreton, Derbyshire DE55 4RF



eurocell.co.uk



Product specification is subject to change without notification.
Please also note that colours shown are illustrative only, as the printing process does not allow 100% accurate colours to be reproduced.